

2=7/16X2 1/4 BOLTS
2=7/16 LOCK NUTS
2=3/16X11/4X7/8 RC
4=7/16 SAE WASHERS

SMI SAVANT
MFG., INC.

GRFR111 FRAME TO MOUNT TO THE HANDLEBARS

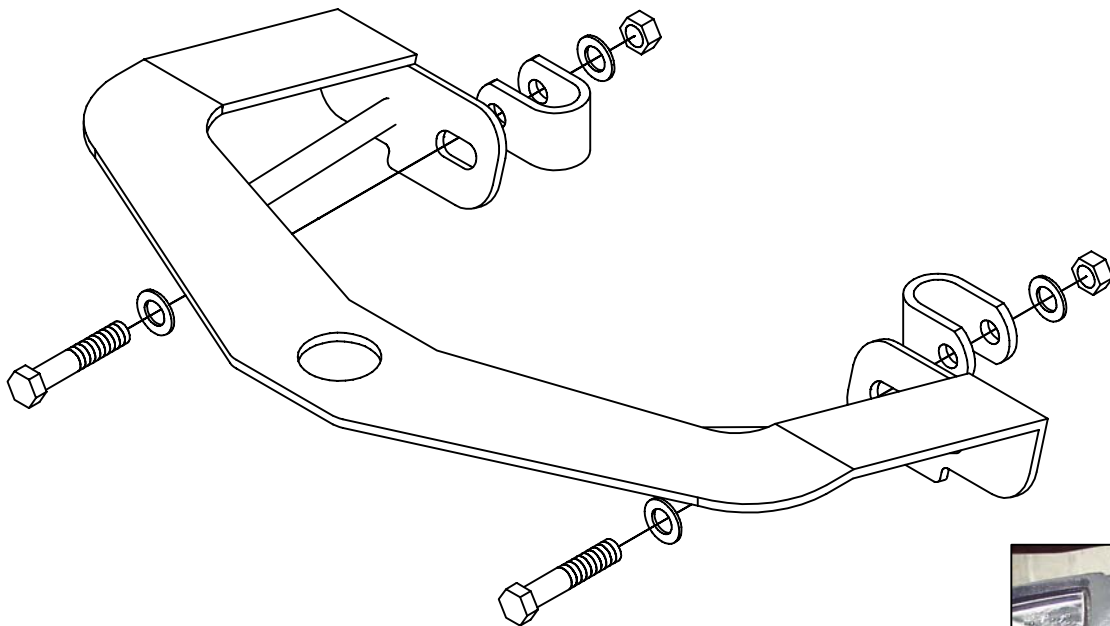

**THE BRACKET WILL MOUNT TO
YOUR HANDLEBARS AS SHOWN IN
PICTURE.**



**ON THE 2002 SUZUKI EIGER THE
CLIPS MUST BE PLACED LIKE
THIS WHERE THE FLIP SWITCH
2WD&4WD
IS LOCATED. LOOSEN THE 8MM
BOLTS THAT HOLED THE
SWITCH PLACE THE CLIP IN
PLACE TIGHTEN THE BOLTS
BACK THEN PROCEED.**